

Study of the Effect of Baffles on Longitudinal Stability of Partly Filled Fuel Tanker Semi-Trailer Using CFD

Hong Duc Thong¹, Tran Minh Tai², and Huynh Phuoc Thien³

Abstract — Sloshing of liquid in partially filled fuel tanker vehicles has a strong effect on the directional stability and safety performance. Under the maneuver of the vehicle, such as steering, braking or accelerating, the liquid fuel in the tanker tends to oscillate. As a result, hydrodynamic forces and moments raise. It leads to reduce the stability limit and the controllability of the vehicle. To minimize the effect of sloshing, the baffles are usually added to the tanker. This paper presents the study of the effect of baffles on the longitudinal stability of the fuel tanker semi-trailer using the computational fluid dynamics (CFD) approach. Three dimensional of a fluid dynamic model of a typical tanker with different baffle configuration is developed. Simulations are performed for the cases of constant acceleration longitudinal maneuvers with different levels of fuel. The post-processing results show that the baffles could provide resistance against the fluid sloshing, resulting in an improvement of the longitudinal stability of the tanker semi-trailer. The results also prove that the benefit of the baffle to the fuel tanker vehicle's stability depends on the size of the baffle, as well as the number of baffles. The 40% height three baffles model is the proper baffle model to resist the longitudinal sloshing in the partially filled tanker of the studied trailer. By adding baffles, shifting of load on the kingpin and the rear axis are less than 5% and 2% as the tanker is filled with 50% and 70% fluid level respectively.

Index Terms — Baffle, longitudinal dynamic fluid slosh, sloshing simulation, tanker semi-trailer.

1 INTRODUCTION

As a tanker semi-trailer with a partially filled liquid tanker is in acceleration or deceleration, the carrying fluid tends

to oscillate. This phenomenon is preferred as sloshing, a form of fluid-structure interaction. One of the major effects of sloshing is to cause the change of the center of gravity of the fluid when the tanker semi-trailer doing the braking or turning maneuver. As a result, the dynamic load shift in the roll and pitch planes could affect the roll and pitch moments, and the mass moments of inertia of the fluid cargo and may lead to a reduction in the directional stability limits and the controllability of the vehicle.

To prevent large scale sloshing, baffles are usually added to the tanker structure. Studies on the effect of baffle configuration on sloshing phenomenon using both theoretical and experimental approach have been carried out for the past several decades. However, only a few theoretical studies deal with the complicated case of sloshing such as tanker semi-trailer in braking or turning maneuver. The experimental approach could give a visual view of sloshing. But, it requires well preparation of equipment such as excitation system, acceleration acquisition system and wave-height measurement system [1]. In addition, it is difficult to carry out the experiment on large testing objects [2].

In recent years, the numerical approach using Computational Fluid Dynamics (CFD) analysis plays an important role in predicting the behavior of fluid-structure interaction in the sloshing. Time and cost-saving can be achieved by using the CFD as a tool to find out the proper model in a group of potential models. Besides that, CFD can deal with the flow limitation and the complicated boundary condition. Several techniques have been used to numerically simulate liquid sloshing, consisting of boundary element integral methods, finite element methods for potential flow, finite difference/volume methods solving the Navier–Stokes equations, and the smoothed particle hydrodynamics method [2]. Among these numerical approaches, the method based on Navier – Stokes solver coupled with the Volume-of-Fluid (VOF) technique is proper to simulate large-amplitude fluid slosh under time-varying excitation acceleration, as well as to track the liquid free surface [3].

In this paper, the study of the effect of baffles configuration on the longitudinal stability of an ellipse cross-section tanker semi-trailer is discussed. The Ansys Fluent software is used to solve the Navier – Stokes equation. The Volume of Fluid model is chosen to formulate the interaction of multiphase of fluid in the tanker [4]. The user-define-function (UDF) is used

Corresponding author: Huynh Phuoc Thien.

¹Hong Duc Thong is with Department of Automotive Engineering, Ho Chi Minh City University of Technology, VNU-HCM, Viet Nam (e-mail: hongducthong@hcmut.edu.vn)

²Tran Minh Tai is with the Department of Automotive Engineering, Cao Thang Technical College, Viet Nam (e-mail: tranminhtai@caothang.edu.vn)

³Huynh Phuoc Thien is with the Department of Automotive Engineering, Cao Thang Technical College, Viet Nam (e-mail: huynhphuocthien@caothang.edu.vn)

to vary the acceleration of the tanker according to the simulation scheme.

2 PHYSICAL MODEL AND STATIC STABILITY ANALYSIS

The study is carried out on the tanker semi trailer’s model of KCT G43-BX40-02 made by Tan Thanh Trading Mechanic Corp, Viet Nam [7]. The main components of the trailer are shown in fig. 1. Detail of load distribution on the kingpin and the rear axes is illustrated in Table 1.

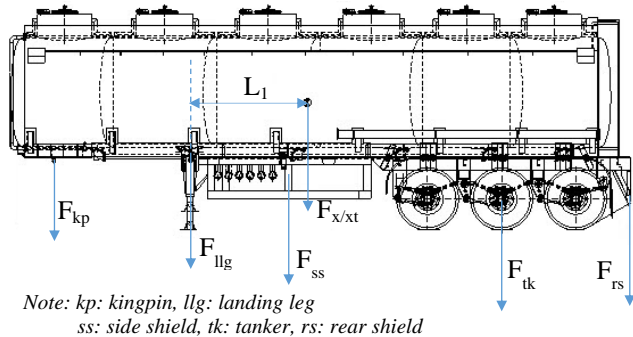

Fig. 1. Forces acting on the trailer

TABLE I
LOAD DISTRIBUTION ON THE KINGPIN AND REAR AXES

N o.	Quantity	Value (kg)	Load on kingpin (kg)	Load on rear axes (kg)
1	Plate to install kingpin	115	115	0
2	Landing leg	150	105	45
3	Side shield	80	40	40
4	Main beam & accessory	3870	0	3870
5	Rear shield & light sys.	150	-45	195
6	Tanker	5050	1960	3090
7	Full gas. load (40 cubic meters)	29600	12840	16760
8	Net weight at zero load	9415	2175	7240
9	Gross weight at full load	39015	15015	24000

3 SIMULATION MODELLING

3.1 Numerical Model

The numerical simulation is done on the fuel tanker semi-trailer G43-BX40-02. To simplify, the tanker is considered to have ellipse cross-section with the dimension of 2.5 m in height 1.96 m in wide. The total length of the tanker is 10.5 m. The fore and aft bulkheads of the tanker are assumed to be flat, and the baffles are also flat. The origin of the coordinate system used is located at the geometric center of the tanker, the x-axis is along the longitudinal axis of the tanker, the z-axis is in the vertical direction. The baffles are installed in the lateral plane with equal distance along the x-axis, and symmetry about the OXY plane axis is in the vertical direction. Figure 2 depicts the overall dimension of the tanker.

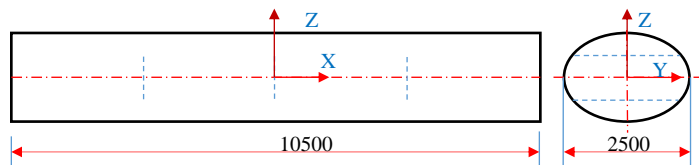

Fig. 2. The tanker’s geometry equipped with three lateral baffles

There baffle configurations that have quantity of baffle of 3, 4, and 5 are considered. On each configuration, the baffles’ height is set to 30%, 40%, and 50% of the tanker’s height. In general, baffles are flat, the overall shape of baffle is similar to the tanker cross-section. The baffle is symmetric about the longitudinal and lateral axes. The baffles that have a height of 40% and 50% of the tanker’s height are shown in figure 3.

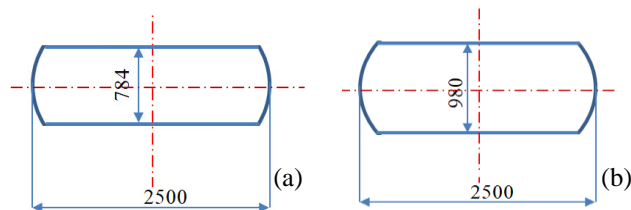

Fig. 3. The shape of the baffle that have a height of 40% (a) and 50% (b)

The simulations were performed under time-varying acceleration along the longitudinal axis as showed in figure 4. In the first 0.1 seconds of the simulation, the acceleration is set to zero. The fuel tanker vehicle is then accelerated at a constant acceleration of 0.7m/s^2 in 7.9 seconds. As the vehicle reaches the velocity of 20 km/h, its acceleration is then set to 0 and remain at that value for the rest of simulation. For all of the simulation, the translation acceleration is set to 9.81m/s^2 in the direction of $-Z$ -axis [5].

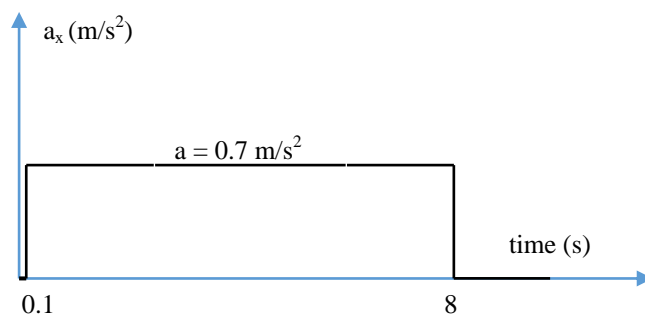

Fig. 4. The acceleration excitation along the longitudinal axis.

3.2 Simulation method

The simulation of sloshing of fluid in the fuel tanker under the time-varying acceleration excitation is done using the commercial Computation Fluid Dynamics software, namely Ansys Fluent version 18.2. The process of simulation and post- processing of the results is illustrated in the flowchart in figure 5.

The Fluid Flow (Fluent) module of Ansys Workbench is used to create the geometry of the tanker and baffles. The unstructured mesh is used to smooth the transition at the tanker wall and the baffles. The mesh quality is controlled to be fined during the automatic mesh generation. The wireframe view of the mesh is shown in figure 6, while the detail of the mesh is listed in Table II.

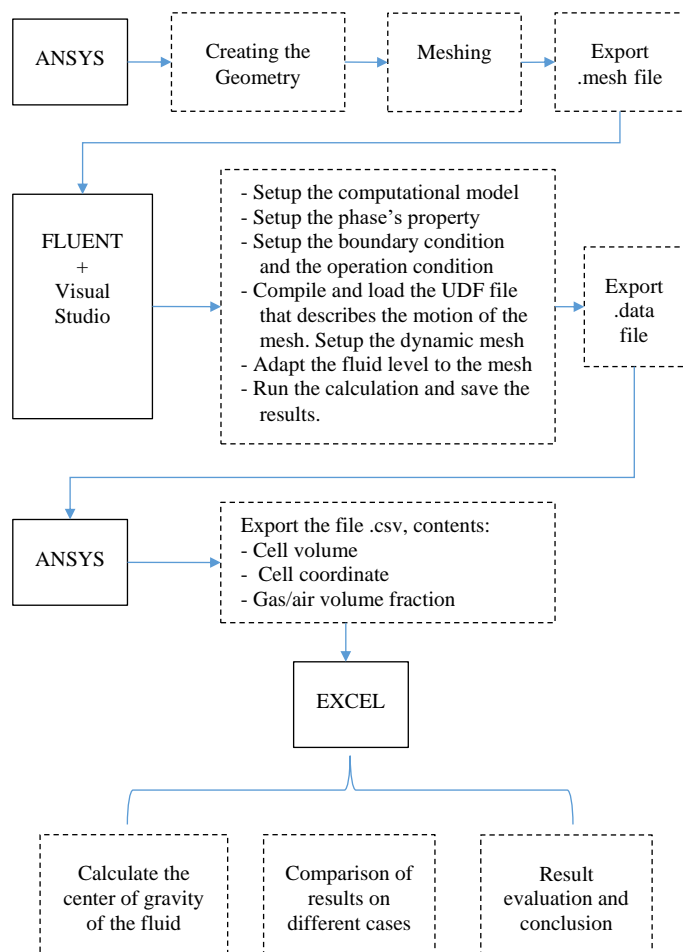

Fig. 5. The process of simulation and result post processing

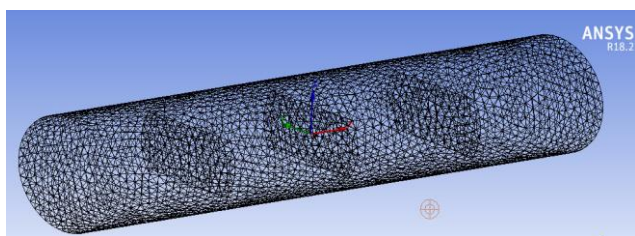

Fig. 6. The wireframe mesh of tanker with 3 baffles, baffle height = 50%

Quantity	30% height	40% height	50% height
Sizing function	Uniform	Uniform	Uniform
Relevance center	Fine	Fine	Fine
Max face size	0.16m	0.16m	0.16m
Defeature size	8e ⁻⁰⁴	8e-04	8e-04
Smoothing	Medium	Medium	Medium
Node	10980	11499	14311
Element	5089	56025	55383

In order to track the center of gravity of the fluid sloshing, the Volume of Fluid (VOF) multiphase model is activated in the solving model of Ansys Fluent. Two phases of air and gasoline are used to represent the gasoline and air in the partially filled tanker. The VOF model was designed to capture the position of the interface between two immiscible

fluids.

The volume fraction of each phase in every cell is tracked throughout the domain by a set of momentum equation between phases. The VOF model relies on the hypothesis that the fluids are not interpenetrating. In each computational cell, the total volume fraction of all phases equal to 1[4]. The detail of the solver and the fluid properties are illustrated in table III.

In order to model the time-varying acceleration motion of the tanker, the User-Defined-Function (UDF file) is used. This file describes the motion of the tankers' geometry according to the model of the tanker's acceleration. By running the Ansys Fluent on the Visual Studio Developer Command Prompt, the UDF file can be built, loaded into a library in Fluent. The functions defined by the UDF file will control the motion of the mesh via the setting in the dynamic mesh task page of Fluent[6].

TABLE III
DETAIL OF MODEL AND PARAMETER SETTING OF THE SOLVER

Model and parameter	Setting
Solving type	Pressure based, time transient
Multiple phase model	Volume of Fluid
Number of Eulerian phases	2
Volume fraction parameter	Explicit
Volume fraction cutoff	1e ⁻⁰⁶
Courant number	0.25
Viscous model	Reliable k - epsilon
Near wall treatment	Scalable wall function
Pressure velocity coupling	SIMPLE
Gradient model	Least squares cell based
Pressure model	PRESTO
Momentum model	Second order upwind
Tracking surface method	Geo - Reconstruct
Transient Formulation	First order implicit
Primary phase	Air
Secondary phase	Gasoline liquid
Air density (kg/m ³)	1.225
Air viscosity (kg/m-s)	1.7894e-05
Gasoline density (kg/m ³) - ρ_{gas}	830
Gasoline viscosity (kg/m-s)	0.00332

3.3 Post processing of simulation results

The exported data is set to contain the information of the volume of each computational cell of the mesh V_c , and the volume fraction of liquid in each cell, $vof(c)_{gas}$. As a result, the mass of liquid in each cell can be calculated by the formula:

$$M_c = \rho_{gas} \cdot V_c \cdot vof(c)_{gas}$$

Three cases are existing for the value of $vof(c)_{gas}$:

- $vof(c)_{gas} = 1$: the cell full of gasoline
- $vof(c)_{gas} = 0$: the cell full of air (empty of gasoline)
- $0 < vof(c)_{gas} < 1$: the cell is partially filled with gasoline (in the free surface between gasoline and air).

By assuming that the center of gravity of fluid in the free surface cell is at the centroid of the cell, the instantaneous center of gravity of the liquid in the tanker can be obtained from the volume integrals over the computational domain. Alternatively, for the discrete mesh, the estimation of the center of gravity is done by:

$$X_{cg} = \frac{\sum x_c \cdot M_c}{\sum M_c}, Y_{cg} = \frac{\sum y_c \cdot M_c}{\sum M_c}, Z_{cg} = \frac{\sum z_c \cdot M_c}{\sum M_c}$$

In which, x_c, y_c, z_c are the coordinate of the centroid of the cell c respect to the original coordinate of the tanker.

4 RESULTS AND DISCUSSIONS

4.1 Static stability

The static stability of the trailer can be obtained by taking into account the load of gasoline to the change of the static center of gravity. As changing the liquid level, the load of fluid will be changed, while the weight of other components is remaining. Resulting in the shifting of the center of gravity, and the redistribution of load on the kingpin and the rear axes. The redistribution load on the kingpin and the rear axes at different mode of liquid fluid level are shown in Table IV.

TABLE IV LOAD ON THE KINGPIN AND THE REAR AXES AT DIFFERENT LOAD MODE OF THE TANKER

Load mode	G_t : Gross weight (kg)	G_{1t} : Load on kingpin (kg)	G_{2t} : Load on rear axes (kg)
100%	29600	12840	16760
90%	26640	11556	15084
70%	20720	8988	11732
50%	14800	6420	8380

The distance from the center of gravity of the liquid fluid in the tanker to the kingpin can be calculated using the formulate: $L_1 = L_0 G_{2t} / G_t = 4.490m$. In which, $L_0 = 7.930$ m is the wheelbase of the trailer.

4.2 Dynamic stability

The dynamic stability of the trailer is evaluated by calculating the shifting of load due to the sloshing of fluid under a time-varying acceleration excitation. At a certain level of fluid in the tanker, the free surface of the liquid will be changed as the sloshing is occurred. As a result, the location of the center of gravity of fluid is varied, leading to a redistribution of load on the kingpin and the rear axes.

The calculation of load on the kingpin during sloshing is done by: $G'_{1t} = G_t \cdot (L_1 + \Delta x_{cg_tanker}) / L_0$. In which, Δx_{cg_tanker} is the shifting of the center of gravity of the liquid fluid obtained from the post processing of simulation results. Therefore, the shifting of load on the kingpin due to sloshing can be obtained by: *load shifting on the kingpin* = $G'_{1t} - G_{1t}$. Similarly, the load and the shifting of load on the rear axes can be obtained by applied the following formulates: $G'_{2t} = G_t - G'_{1t}$, and *load shifting on the rear axes* = $G'_{2t} - G_{2t}$.

To study the effect of the quantity of baffle to the dynamic stability of the semi-trailer, the lateral baffles are inserted to the tanker. The baffle's height equals 40% the height of the tanker, while the baffle quantity is set to be three, four, or five baffles. In these simulation cases, the gasoline is set up at 70% of the tanker volume. The simulation result in term of volume fraction of gasoline is depicted in figure 7.

As seen in Fig. 7a, b, c, the liquid fluid is moving toward the rear of the tanker at the time of observation. Therefore, it can be predicted that dynamic load will increase in the rear of the tanker, and decrease in the front of the tanker. Detail of the redistribution of load on the kingpin and the rear axes is

shown in Table V, the static gross weight of the trailer is 20720 kg.

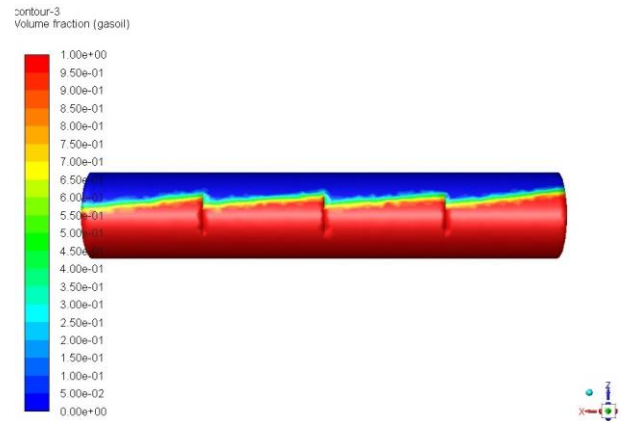

Fig. 7a. Volume fraction of gasoline on 3 baffles model

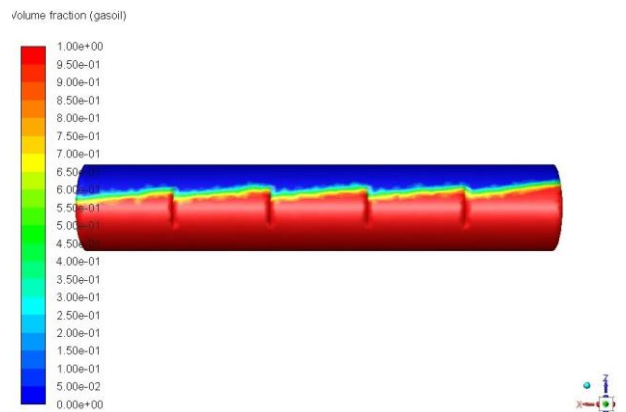

Fig. 7b. Volume fraction of gasoline on 4 baffles model

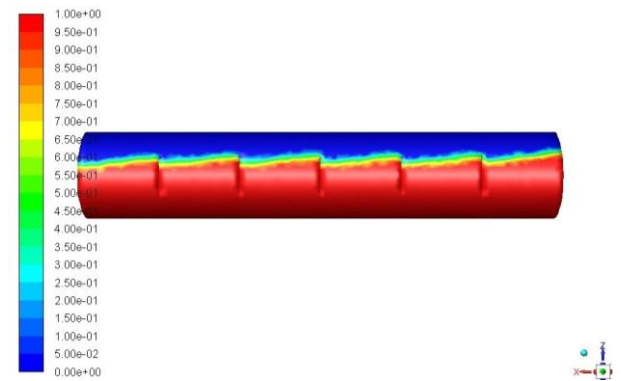

Fig. 7c. Volume fraction of gasoline on 5 baffles model

TABLE V EFFECT OF THE NUMBER OF BAFFLE ON THE LOAD REDISTRIBUTION

Baffle model	Static load (kg)		Dynamic load (kg)		Shifting of load (%)	
	King-pin	Rear axes	King-pin	Rear axes	King-pin	Rear axes
3 baffles	8988	11732	8841	11879	-1.64	1.26
4 baffles	8988	11732	8516	12204	-5.26	4.03
5 baffles	8988	11732	8919	11801	-0.76	0.59

Figures 8 and 9 illustrate the amount of changing in the load distribution on the kingpin and the rear axes at different baffle configuration.

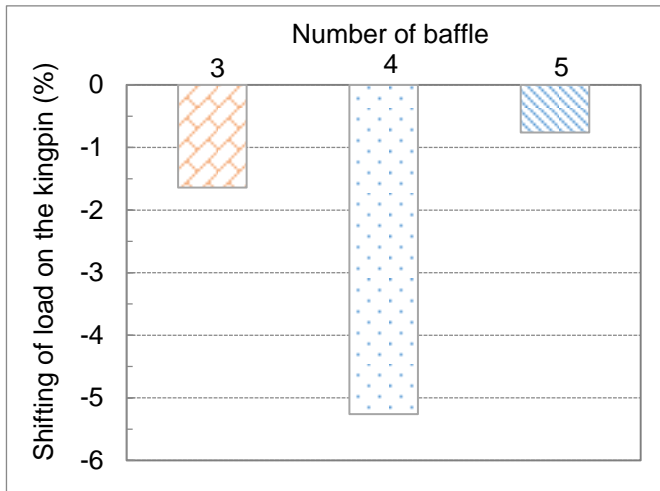

Fig. 8. Effect of the number of baffle on the shifting of load on the kingpin

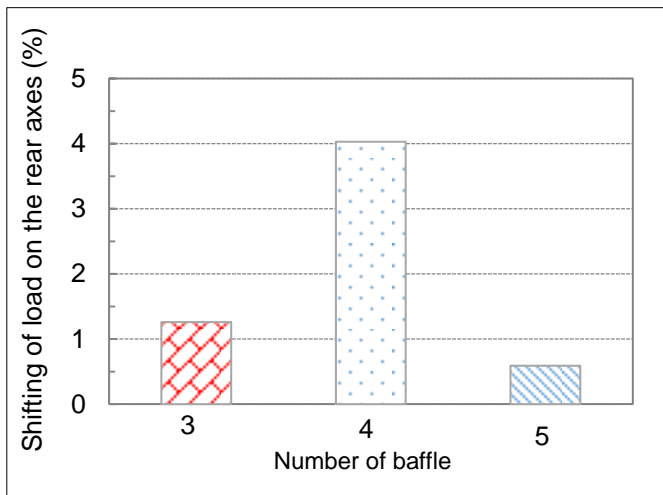

Fig. 9. Effect of the number of baffle on the shifting of load on the rear axes

As seen in figures 8 and 9, the baffles help to slow down the redistribution of load on the kingpin and the rear axes. The three and five baffle models give good results in preventing the shifting of the center of gravity of the trailer in comparison with the model of four baffles. At the time of observation, it can be recognized in all cases of the simulation that load is reduced on the kingpin and increase on the rear axes.

In comparison to the three baffles model, the model with five baffles provides better resistance against the sloshing. The reduction of load on the kingpin of five baffles model (0.76%) is lightly smaller than in the three baffles model (1.64%). The increase of load on the rear axes of the five baffles model (0.59%) is a little bit smaller as compared with the case of the three baffles model (1.26%).

However, as evaluating the term of cost and simplicity, the three baffles model has more advantages than the five baffles model. Therefore, the tanker with three lateral baffles will be used for further study on the effect of baffle height on the

longitudinal stability of the trailer.

Three baffle height of 30%, 40%, and 50% are used to find out which model will give better results in reducing of shifting of the center of gravity of the trailer as under sloshing. The simulation results in terms of volume fraction of fluid for the liquid level of 50% are depicted in Figure 10a, b, c.

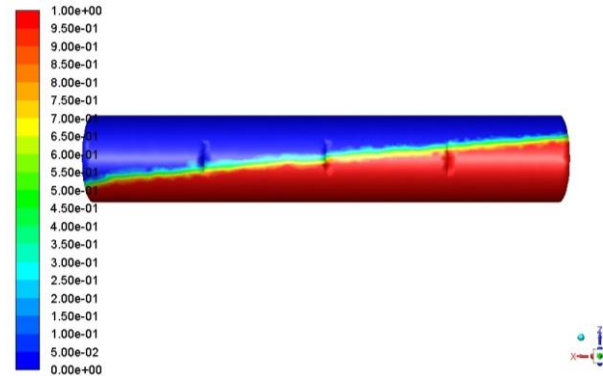

Fig. 10a. Volume fraction of gasoline on 30% baffle height model,

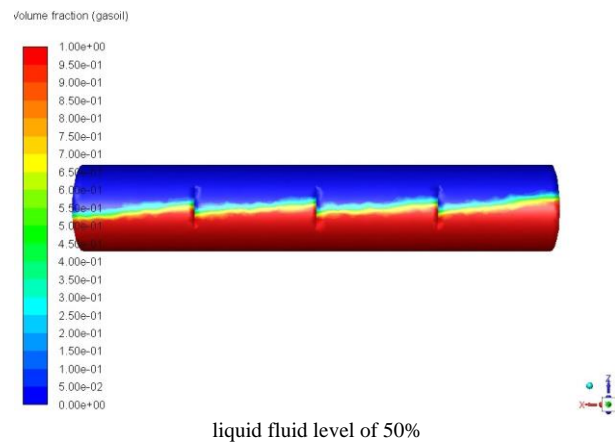

Fig. 10b. Volume fraction of gasoline on 40% baffle height model, liquid fluid level of 50%

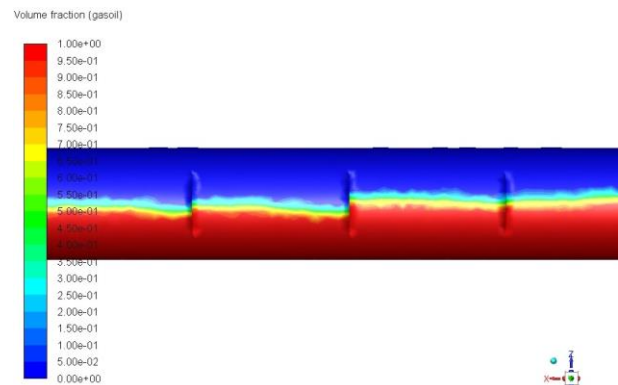

Fig. 10c. Volume fraction of gasoline on 50% baffle height model, liquid fluid model of 50%

Detail of load distribution on the kingpin and the rear axes at the static condition and sloshing is shown in Table VI.

TABLE V EFFECT OF BAFFLE'S HEIGHT ON THE LOAD REDISTRIBUTION – FLUID LEVEL OF 50%

Baffle height (%)	Static load (kg)		Dynamic load (kg)		Shifting of load (%)	
	King-pin	Rear axes	King-pin	Rear axes	King-pin	Rear axes
30	6420	8380	4326	10474	- 32.61	24.99
40	6420	8380	6206	8594	- 3.33	2.55
50	6420	8380	5853	8947	- 8.83	6.76

At the liquid fluid level of 50%, the baffle model of 30% baffle height has less effect on reducing the movement of the fluid. As shown in figure 10a, the fluid tends to move toward the right end of the tanker at the time of observation. Therefore, the dynamic load significantly increase on the rear axes of the tanker (24.99%), and highly reduce on the kingpin (32.61%).

In the models that have a baffle height of 40% and 50%, the baffles effectively limit the oscillation of fluid. As a result, the shifting of the center of gravity of the fluid is rather small as compared with the 30% baffle height model.

Among the three models of baffle height, the model of 40% baffle height gives the smallest movement of the center of gravity of the trailer, resulting in the smallest shifting of load on the kingpin and the rear axes (-3.33% and 2.55%). This dominance of the 40% baffle height model will be validated on other liquid fluid levels of 70% and 90%. The simulation result of these cases is detailed in Table VI and VII.

TABLE VI EFFECT OF BAFFLE'S HEIGHT ON THE LOAD REDISTRIBUTION – FLUID LEVEL OF 70%

Baffle height (%)	Static load (kg)		Dynamic load (kg)		Shifting of load (%)	
	King-pin	Rear axes	King-pin	Rear axes	King-pin	Rear axes
30	8988	11732	7633	13087	-15.07	11.55
40	8988	11732	8841	11879	-1.64	1.26
50	8988	11732	8104	12616	-9.83	7.53

The simulation result of the 70% liquid level is similar to the case of the fluid level of 50%. The 40% baffles' height model gives the best result in preventing the load shifting, while the largest load shifting occurs in the 30% baffles' height model. The volume fraction of gasoline for three models of baffle height is illustrated in figure 11.

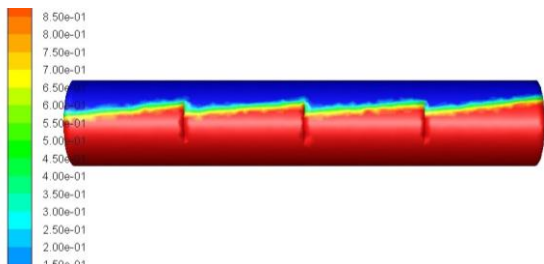

Fig. 11a. Volume fraction of gasoline on 30% baffle height model, liquid fluid level of 70%

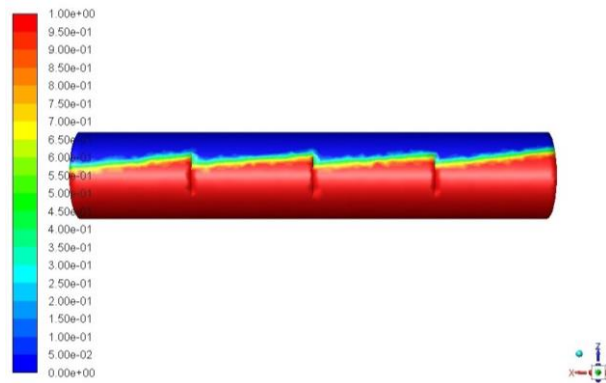

Fig. 11b. Volume fraction of gasoline on 40% baffle height model, liquid fluid level of 70%

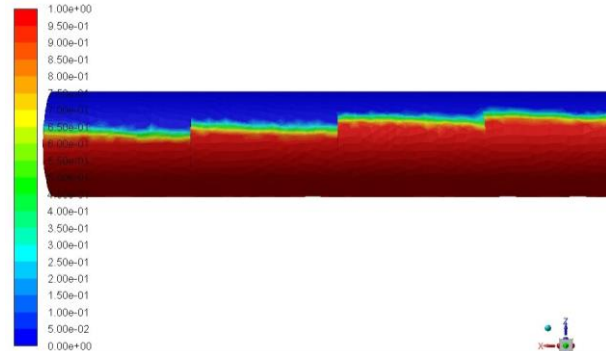

Fig. 11c. Volume fraction of gasoline on 50% baffle height model, liquid fluid level of 70%

The result of load shifting for the case of 90% liquid level is shown in Table VII. The volume of fluid on the computational domain is depicted in figure 12. It can be seen that the fluid does not have much space for sloshing. With the baffle height of 30% and 40% the baffles nearly submerge in the liquid fluid and have less effect in reducing the fluid oscillation. Baffle height of 50% provides a better reduction of sloshing, resulting in the smallest load shifting in the kingpin and the rear axes among the there model of baffle height.

TABLE VII EFFECT OF BAFFLE'S HEIGHT ON THE LOAD REDISTRIBUTION – FLUID LEVEL OF 90%

Baffle height (%)	Static load (kg)		Dynamic load (kg)		Shifting of load (%)	
	King-pin	Rear axes	King-pin	Rear axes	King-pin	Rear axes
30	11556	15084	10445	16195	-9.61	7.37
40	11556	15084	10574	16066	-8.5	6.51
50	11556	15084	10790	15850	-6.63	5.08

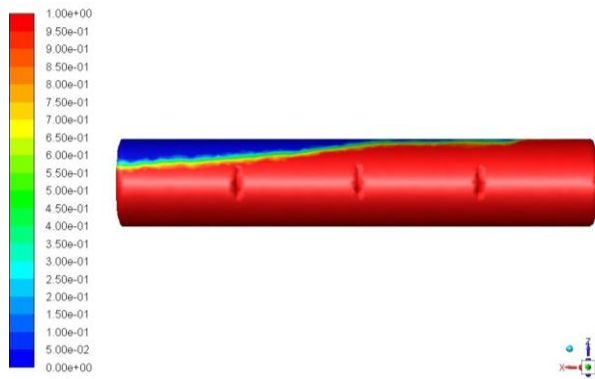

Fig. 12a. Volume fraction of gasoline on 30% baffle height model, liquid fluid level of 90%

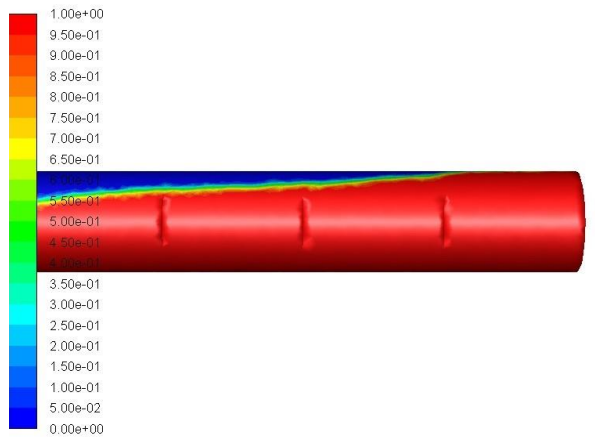

Fig. 12b. Volume fraction of gasoline on 40% baffle height model, liquid fluid level of 90%

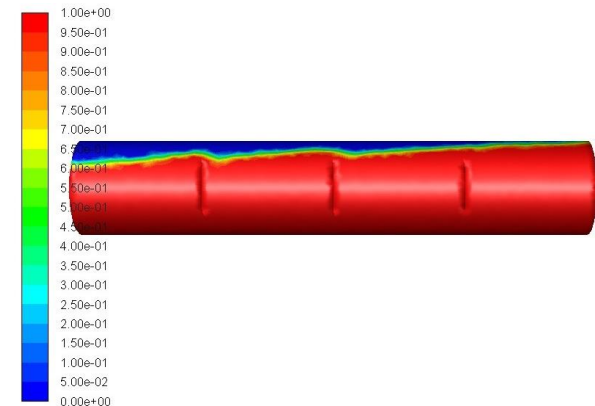

Fig. 12c. Volume fraction of gasoline on 50% baffle height model, liquid fluid level of 90%

5 CONCLUSIONS

The study of the effect of adding lateral baffles on the longitudinal stability of a tanker semi-trailer has been conducted by using a computational fluid dynamics approach. Lateral baffles characteristic in terms of a number of the baffle, and height of baffle have been examined to find out the appropriate baffle configuration.

It could be concluded that the simulation approach using multiphase Volume of Fluid Model in Ansys Fluent can be used to capture the air-liquid fluid interface. Analyses of the simulation results show that lateral baffles could be damping

the oscillation of fluid under sloshing.

The 40% height three baffles model is the proper tanker model to resist the longitudinal sloshing in the partially filled tanker of the studied trailer.

Validation on different liquids levels shows that the effectiveness of the baffle against the sloshing is high at a low liquid level. This effect reduces as the tanker is full or nearly full of liquid.

REFERENCES

- [1] Li-Shi Wang, Zhuang Wang, Yu-Chun Li, "Two-dimensional nonlinear parametric sloshing in the irregular tanks: numerical analysis and experimental investigation" *JVE International Ltd. Journal of Vibroengineering*, vol. 19, pp. 2153 – 2163, 2016
- [2] Minh Ha, Daehwan Kim, Hu In Choi 2, Cheolung Cheong and Sun Hong Kwon, "Numerical and experimental investigations into liquid sloshing in a rectangular tank", in *Proc. The 2012 World Congress on Advances in Civil, Environmental, and Materials Research, Seoul, Korea, 2012*, pp. 3546 – 3553.
- [3] T. Kandasamy, S. Rakheja and A.K.W. Ahmed, "An Analysis of Baffles Designs for Limiting Fluid Slop in Partly Filled Tank Trucks", *The Open Transportation Journal*, vol. 4, pp. 23 – 32, 2010.
- [4] Vaibhav Singala, Jash Bajajb, Nimish Awalgankara, Sarthak Tibdewalc, "CFD Analysis of a Kerosene Fuel Tank to Reduce Liquid Sloshing", *Procedia Engineering*, vol. 69, pp. 1365 – 1371, 2014.
- [5] Tran Minh Tai, "Nghiên Cứu Tối Ưu Vách Ngăn Xi-Téc Để Nâng Cao Tính Năng Động Lực Học Của Sômi Rơ-Môóc Chở Xăng", M.S. thesis, Depart. of Automotive and Engine, Hochiminh City University of Technology, HCM city, VN, 2019.
- [6] Simulation of Wave Generation in a Tank, Fluent Tutorial, [Online] Available: <http://willem.engen.nl/uni/fluent/documents/external/wave.pdf>. Accessed on August 1st, 2019.
- [7] G43-BX40-02 Tanker Semi Trailer specification, [Online] Available: <https://tanhanhcontainer.com/wp-content/uploads/2018/06/G43-BX40-02-E.pdf>. Accessed on August 1st, 2019.



Hong Duc Thong was born in Ho Chi Minh City, Vietnam in 1980. He received the B.E. (2003) and M.E. (2005) degrees in automotive engineering from the Ho Chi Minh City University of Technology, Vietnam and D.E. (2014) degree in mechanical engineering from Intitute Teknology Bandung, Indonesia – Hokkaido University, Japan. From 2005 to 2018, he was a lecturer of Department of Automotive Engineering, Ho Chi Minh City University of Technology, VNU-HCM. Since 2019, he has been a deputy head of Department of Automotive Engineering. His research interest includes renewable and alternative fuels, internal combustion engine.



Huynh Phuoc Thien received the B.E. degree from Ho Chi Minh City University of Technology, Vietnam in 2006. He received the M.E. degree in aeronautical engineering from Bandung Institute of Technology, Indonesia in 2008.

From 2008 to 2012, he participated in the doctoral sandwich program between Bandung Institute of Technology and the University of Tokyo, sponsored by the Japan International Cooperation Agency. And, he receive his Ph.D. degree in 2012.

Dr. Thien jointed in the Department of Automotive Engineering, Cao Thang Technical College, Vietnam from

2012 as a lecturer. His research interest includes system identification, computational fluid dynamics, and digital image processing.



Tran Minh Tai was born in Ho Chi Minh City, Vietnam in 1984. He received the B.E. degree in automotive engineering from the Ho Chi Minh City University of Technology, Vietnam in 2007. From 2014 to 2019, he has studied the B.E. in automotive engineering at the Ho Chi Minh City University of Technology, Vietnam. From 2007 to 2019, he has been a lecturer of Department of Automotive Engineering, Cao Thang Technical College. His research interest includes computational fluid dynamics, automobile stability and control.

Nghiên Cứu Tác Dụng Của Vách Ngăn Đối với Sự Ổn Định Dọc Của Sômi Rơ-Moóc Chở Xăng Sử Dụng Phương Pháp Mô Phỏng Số

Tác giả: Hồng Đức Thông, Trần Minh Tài, và Huỳnh Phước Thiện

Tóm tắt Sự sóng sánh của chất lỏng trong bồn chứa không đầy tải có ảnh hưởng rất lớn đến ổn định dọc và sự vận hành an toàn của sômi rơmoóc bồn nhiên liệu. Khi xe chuyên hướng, tăng tốc hoặc phanh, chất lỏng trong bồn có xu hướng dao động. Kết quả là các lực và mô men thủy động sẽ xuất hiện làm giảm giới hạn ổn định và khả năng điều khiển của xe. Để hạn chế tác động của dao động sóng sánh, các vách ngăn thường được thêm vào cấu trúc của bồn. Trong bài báo này, nghiên cứu về tác dụng của vách ngăn đối với sự ổn định dọc của sômi rơ-moóc chở xăng sử dụng phương pháp số sẽ được trình bày. Một mô hình tính toán số ba chiều với các cấu trúc khác nhau của vách ngăn được xây dựng phục vụ cho việc mô phỏng. Mô phỏng được tiến hành cho trường hợp xe được gia tốc đều theo phương dọc trục với các mức tải khác nhau trong bồn chở xăng. Việc phân tích kết quả mô phỏng cho thấy các vách ngăn có khả năng chống lại các dao động sóng sánh trong bồn, kết quả là làm cải thiện ổn định dọc của phương tiện. Các kết quả tính toán cũng cho thấy ổn định dọc của xe bồn phụ thuộc vào số lượng và kích thước của vách ngăn. Mô hình bồn với ba vách ngăn có chiều cao vách bằng 40% chiều cao bồn cho kết quả tốt nhất trong việc làm giảm thiểu sự sóng sánh của chất lỏng theo phương dọc trục trên xe bồn khảo sát. Bằng cách thêm vào các vách ngăn, sự thay đổi tải trọng trên chốt kéo và trên trục sau có thể nhỏ hơn 5% và 2% khi mức xăng trong bồn lần lượt ở mức 50% và 70% chiều cao bồn.

Từ khóa – Vách ngăn, ổn định dọc của chất lỏng trong bồn, mô phỏng sự sóng sánh của chất lỏng trong bồn chứa, xe bồn.